

Operating Guide

Dismantle tool [Schleuse]

[EN] Replacement tool and instructions for exchanging Danfoss valve insert in valve RAVL, RAV and RA 2000 in a non-drained system

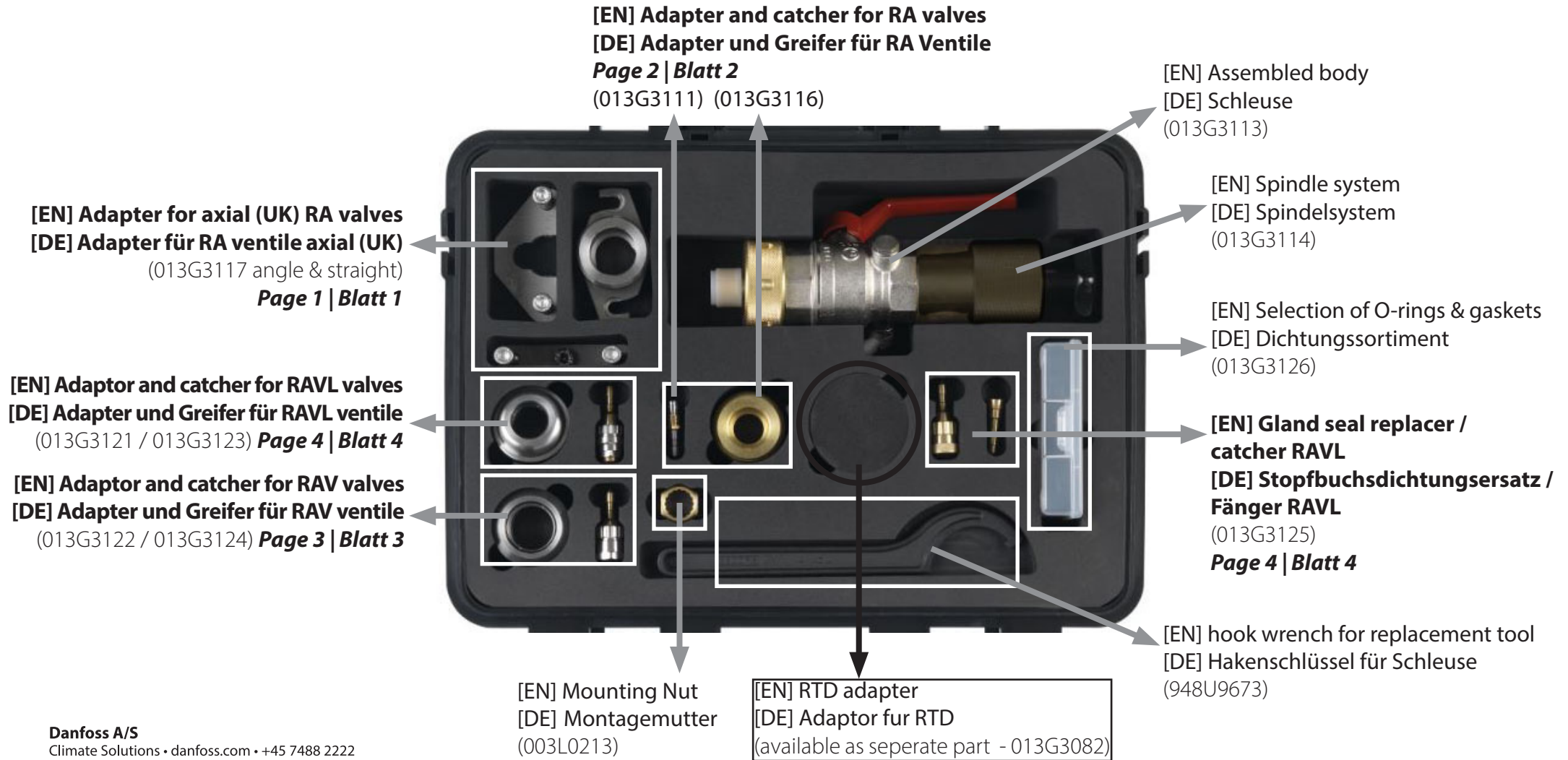







[DE] Werkzeug und Anleitungen zum Austausch von Danfoss RAVL, RAV und RA 2000 Ventileinsätzen bei Anlagedruck





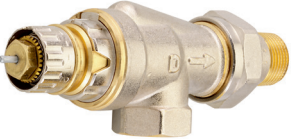

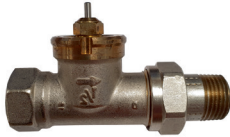

Danfoss A/S
Climate Solutions • danfoss.com • +45 7488 2222

Any information, including, but not limited to information on selection of product, its application or use, product design, weight, dimensions, capacity or any other technical data in product manuals, catalogues descriptions, advertisements, etc and whether made available in writing, orally, electronically, online, or via download, shall be considered informative, and is only binding if and to the extent, explicit reference is made in a quotation or order conformation. Danfoss cannot accept any responsibility for possible errors in catalogues, brochures, videos, and other material. Danfoss reserves the right to alter its products without notice. This also applies to products ordered but not delivered provided that such alterations can be made without changes to the form, fit or function of the product. All trademarks in this material are property of Danfoss A/S or Danfoss group companies. Danfoss and the Danfoss logo are trademarks of Danfoss A/S. All rights reserved.

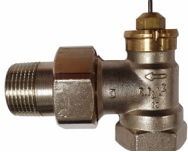
[EN] Valve types, valve inserts/replacement list
 [DE] Ventiltypen, Ventileinsätze/Austauschliste

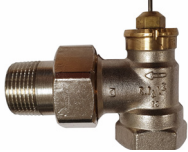
RA	Size	Type	Service Insert
 <p>RA-N</p>	<p>10 (3/8")</p> <p>15 (1/2")</p>	<p>Angle/ Double Angle/ Straight</p>	 <p>013G3063</p>
 <p>RA-N</p>	<p>20 (3/4")</p>	<p>Angle/ Axial/ Straight</p>	 <p>013G3064</p>
 <p>RA-N / RA-U</p>	<p>10 (3/8")</p> <p>15 (1/2")</p>	<p>Axial (UK)</p>	 <p>013G3065</p>
 <p>RA-U</p>	<p>10 (3/8")</p> <p>15 (1/2")</p> <p>20 (3/4")</p>	<p>Angle/ Straight</p>	 <p>013G3066</p>

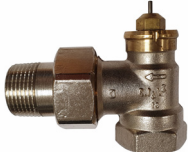
RA/V		Size	Service Insert	RA Upgrade Insert
	10-8	10 (3/8")	013U0252	 <p>013G4013</p>
	15-8	15 (1/2")		
	20-8	20 (3/4")	013U0253	
RA/VL	Kv	Size		
	0.5 / 0.8	10 (3/8")	013L0248	 <p>013G4011</p>
	0.5 / 0.8	15 (1/2")	013L0249	
	1.3	20 (3/4")	013L0249	 <p>013G4012</p>
	0.2	10 (3/8")	013L0248	<p>(Not available Nicht verfügbar)</p>
		15 (1/2")	013L0249	
		20 (3/4")		